

WARRANTY 3 YEARS
PARTS & LABOUR



Turbo air

SALAD TABLE - BUFFET

REFRIGERATOR

MODEL : KSR15-2-N / KSR15-2(HC)

FEATURES / BENEFITS

Digital temperature control & monitor system

Keep food products safe by maintaining constant temperatures. External digital display allows for easy monitoring.

Hydrocarbon(HC) refrigerants (R-290)

With innovative and eco-friendly technology, Turbo Air brings you hydrocarbon refrigerators designed to meet DOE's Energy Conservation Standards in 2017 and to use EPA's SNAP Program approved HC refrigerants. Hydrocarbon refrigerants do not deplete the ozone layer and have very low affect to global warming (ODP-0, GWP-3).

Side mount compressor unit

With compressors positioned on the side of the unit, our refrigerators can now be serviced without being moved. Our innovative, front breathing feature also allows this model to be highly efficient in narrow spaces.

Exterior & interior of the cabinet

The Turbo Air K-series boasts a stainless steel exterior (galvanized steel back and bottom). Interior is stainless steel floor with AL sides, back and AL door liners. It guarantees the utmost in cleanliness and long product life. The K-series adds a touch of style to the most refined setting.

High-density polyurethane insulation

The entire cabinet structure and solid doors are foamed-in-place using high density, CFC free polyurethane insulation.

Hot gas condensate system

Through Turbo Air's creative innovation, the condensate system surfaces have been specially treated to resist corrosion. This not only increases efficiency without the risk of refrigerant leakage from corrosion, but also thoroughly prevents the overflow of condensate water.

Ergonomically designed doors

Customers' fatigue fades away with easy grip handles and doors that open effortlessly. These features along with self-closing doors make this the ultimate choice in customer convenience.

Adjustable, heavy duty, PE (polyethylene) coated wire shelves

Easy open front grille with condenser cleaning brush kit

Front grille cover is easily removable without any tools, which makes condenser cleaning easy and convenient at any time. Handy condenser cleaning brush is included inside the front grille cover.

The Meat function allows the compressor to run continuously for up to 2 hours. When activated, the temperature drops to freezing temperature. This is ideal when you put new stock and need to chill it quickly. Also for aging meat and fish to an ideal temperature. Please note it will freeze contents so use this function for a short time.

Refrigerator holds 1°C ~ 8°C for the best in food preservation

NATURAL Refrigerant Front Breathing



- Pans not included.



LED interior lighting & fan control (only at Turbo Air)

Energy efficient LED lighting lights every corner, making items easy to find. Fan control function automatically shuts off the fan when the door is open, which prevents hot air from being drawn in, thus maintaining the cool inner temperature.

Standard features

- Anti-corrosion coated evaporator
- Self-contained system
- Standard 125mm. swivel castors with locks on the front set
- Door locks standard

Optional features

- 125mm castors fitted
- 180mm, 105mm, 80mm castors optional
- Adjustable legs 100-155mm, 70-90mm

REFRIGERATOR MANUFACTURER
Turbo air

■ WARRANTY: 3 Year Parts and Labour Warranty

SALAD TABLE - BUFFET

Model	KSR15-2-N(HC)
Refrigerant	R-290
COMP (HP)	110
POWER INPUT(W)	2/5HP
Energy consumption	280
AMPS(A)	NO
Capacity	420
Product Dimension	1500
Product Dimension	700
Product Dimension	855
Weight	91
Stainless steel	SUS 439
Features	FB + HC
Max GN Pan depth	150mm
GN Pan	Not included
Door lock	yes
Adjustable Shelves	2
LED light	no
Temperature range	1°C~8°C
Ambient	35°C
Drainage /	SOP PAPER
Temperature control	Digital control
Cooling type	FAN COOLING
Glass Type (Low-e / Heater / How many layer of the glass)	

Design and specifications subject to change without notice.
Actual shipping weight may differ due to extra packing materials for product protection.

- DOOR LOCKS STANDARD
- SELF-CONTAINED SYSTEM
- STANDARD 4" SWIVEL CASTERS WITH LOCKS ON THE FRONT SET
- STANDARD 1/6 SIZE, 100MM DEEP CONDIMENT PANS INCLUDED
- 240MM DEEP, 12MM THICK CUTTING BOARD INCLUDED

PLAN VIEW

(unit : mm)

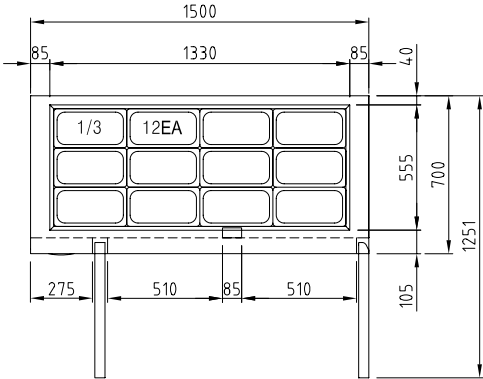

PLAN VIEW

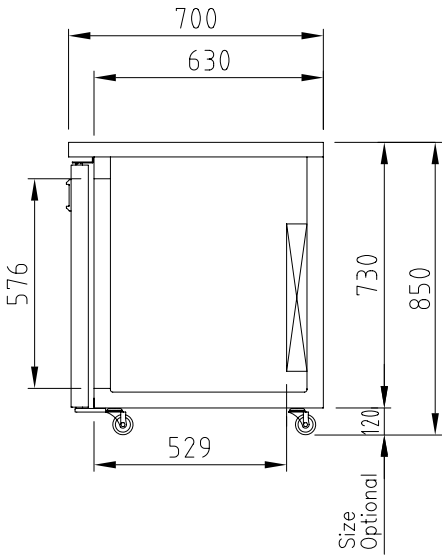

SIDE VIEW

WARRANTY 3 YEARS
PARTS & LABOUR



AUSTRALIA BRANCH

Turbo air

email : TA.admin@turboairinc.com.au

TURBO AIR PTY LTD
www.turboairinc.com.au
 1st Floor, Building E
 10 Highgate St, Auburn
 NSW 2144 Australia
 T. 02 9737 9881